

AUDEIA

CU501 /x

AASER PRO Central Unit

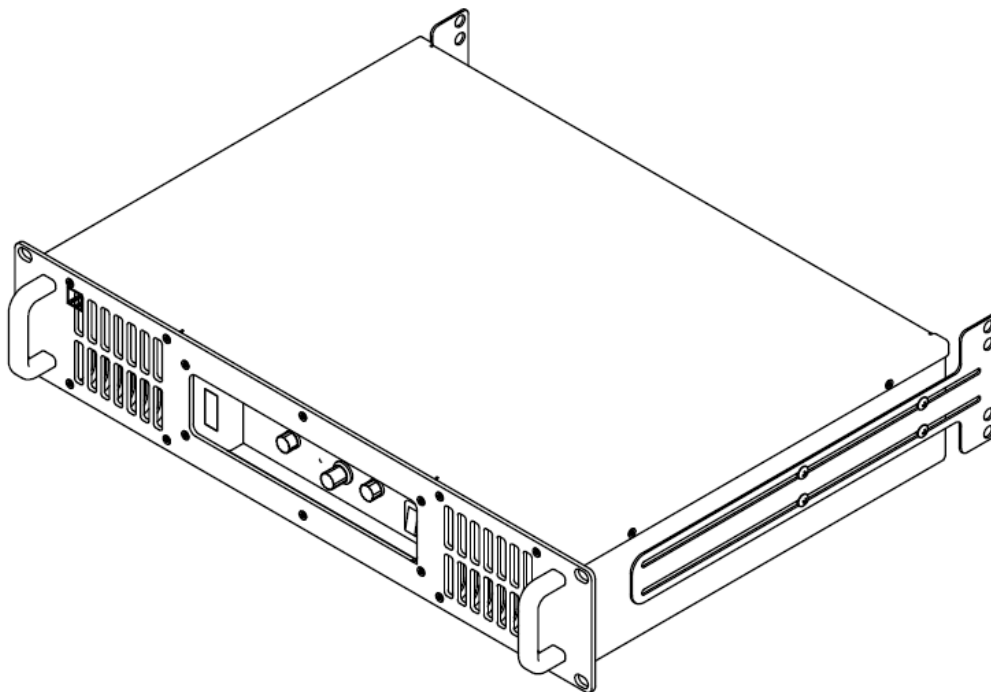

USER MANUAL



SIMBOLS

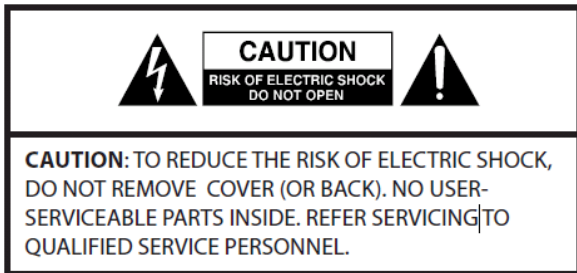

WARNING: TO PREVENT FIRE OR SHOCK HAZARD, DO NOT EXPOSE THIS APPLIANCE TO RAIN OR MOISTURE.



The lightning flash with arrowhead symbol (as the one in the left) is intended to alert the user to the presence of dangerous voltage within the product enclosure that may constitute a risk of electric shock to person.



The exclamation point within an equilateral triangle (as the one in the left), is intended to alert the user to the presence of important instruction concerning the use of the appliance.

SAFETY INSTRUCTIONS

- Read these instructions
 - Keep these instructions
 - Heed all warnings
 - Trail all instructions
 - Do not use this apparatus near water
 - Clear only with dry cloth
 - Install in accordance with the manufacturers instructions
 - Do not install near any heat sources such as radiators, heat registers, stoves, or other apparatus (including amplifiers) that produce heat
 - No naked flame sources, such as lighted candles, should be placed on the apparatus.
 - Do not block any ventilation openings.
 - Do not defeat the safety purpose of the polarized or grounding type plug
 - Ensures the source voltage matches the voltage of the power supply before turning ON the apparatus.
 - If the provided plug does not fit into your outlet, consult an electrician for replacement of the obsolete outlet.
 - Protect the power cord from being walked on or pinched particularly at the plug, convenience receptacles, and the point where they exit from the apparatus.
 - Unplug this apparatus during lightning storms or when unused for long periods of time.
- There are maybe some areas with high voltages inside, to reduce the risk of electric shock, do not remove any cover if the power supply is connected. The cover should be removed by qualified personnel only. No user serviceable parts inside.
 - This apparatus shall not be exposed to dripping or splashing and that no objects filled with liquids, such as vases, shall be placed on this apparatus.
 - To reduce the risk of fire or electric shock, do not expose this apparatus to rain or moisture.
 - Only use attachments/accessories specified by the manufacturer.
 - Refer all servicing to qualified personnel. To reduce the risk of electric shock, do not perform any servicing other than that contained in the operating instructions unless you are qualified to do so.
 - Servicing is required when the apparatus has been damaged in any way, such as the power supply cord or plug is damaged, liquid has been spilled or objects have fallen into the apparatus, the apparatus has been exposed to rain or moisture, does not operate normally, or has been dropped.
 - Make sure to connect the protective grounding to prevent any electric shock before turning ON the apparatus.
 - The external wiring connected to the output hazardous live terminals requires installation by an instructed person, or the use of ready-made leads or cords.
 - Never cut off the internal or external protective grounding wire or disconnect the wiring of protective grounding terminal.

DISPOSAL OF ELECTRICAL AND ELECTRONIC EQUIPMENT

- All the electrical and electronic equipment should be disposed separately from the municipal waste via collection facilities designed by the government or local authorities.
- By disposing of electrical and electronic equipment correctly you help to save valuable resources and prevent any potential negative effects on human health and the environment.
- Improper disposal of waste electrical and electronic equipment can have serious effect on the environment and human health because of the presence of hazardous substances in this type of equipment.
 - The waste electrical and electronic equipment (WEEE) symbol, which show a bin that has been crossed out, indicates that electrical and electronic equipment must be collected and disposed of separately from household waste.
- Return and collection systems are available to end users. For more detailed information about the disposal of old electrical and electronics equipment, please contact your city office of waste disposal service or the shop where you purchased the equipment.



SAFETY PRECAUTION

- SIMBOLS 2
- SAFETY INSTRUCTIONS..... 2
- DISPOSAL OF ELECTRICAL AND ELECTRONIC
EQUIPMENT 2
- INCLUDED ITEMS 4
- ABOUT THIS MANUAL..... 4
- LEGAL DISCLAIMER..... 4
- PRECAUTION FOR INSTALLATION AND USE . 4
- WARRANTY 4
- OVERVIEW..... 5
- FRONT PANEL..... 5
- REAR PANEL 5
- TECHNICAL SPECIFICS 7

Thank you for purchasing the AUDEIA CU501/x System. For the best use of the CU501/x central unit please read this user's manual carefully, and keep it in safe place for future reference.

INCLUDED ITEMS

Following are listed included items, please contact the store where you purchased this unit if any of listed items are missing or have been damaged during transportation.

- The CU501x unit Q.ty 1
- AC power cord Q.ty 1
- USB cord Q.ty 1
- Owner's manual (this manual) Q.ty 1

ABOUT THIS MANUAL

This manual is composed of five main sections: "SAFETY PRECAUTION" in which there are safety information and instructions; "CONTENTS" with the table of contents; "INTRODUCTION" a brief description to introduce you in the use of apparatus; "INSTRUCTION" with technical information concerning installation and usage; "TECHNICAL DATA" with technical specifics.

Each section name is printed on the top side of the manual.

LEGAL DISCLAIMER

AUDEIA, RSS, AASER and the other names of apparatus or components are trademarks or registered trademarks of respective owner.

No part of this manual may be reproduced or copied without write permission of AUDEIA.

AASER technology is world patented solution.

Technical specification and appearance are subject to change without notice.

PRECAUTION FOR INSTALLATION AND USE

- The operating temperature should be between 4°C and 36°C
- To prevent degrade of sound quality and malfunction do not install in places with significant vibration, exposed to direct sunlight, in extremely hot places, in places with high humidity or bad ventilation, places exposed to rain or other water.
- Do not place anything on the unit
- Do not expose to fast reduction of temperature because condensation could occur with possible damaging of the apparatus. If this happens, leave the unit for one or two hours before turning the unit on.

- Avoid installing this unit on top of any heat-generating devices as power amplifiers also to avoid condensation.
- To clean the unit, wipe it lightly with a soft dry cloth. Do not wipe with cleaning cloths, paint thinner, benzene, ethyl alcohol or other agents. This could damage the surface.

WARRANTY

To obtain Warranty Service, the buyer should first fill out and return the enclosed Warranty Registration Card compiled in every part within 10 days of the Purchase Date.

In case of return for any warranty service, please make sure that the product is well packed in its original shipping carton, and it can protect your unit from any other extra damage.

Please provide a copy of your sales receipt and give detail information about your return address and contact telephone number.

The warranty service is only available to the original consumer, who purchased this product directly from the retail dealer, and it can not be transferred.

The warranty does not apply to the damages to this product that occurred as the following conditions:

- Normal tear and wear.
- Any abuse or misuse of this product, or use not in accordance with this manual.
- The product has been altered or modified in any way.
- Damage which may have been caused either directly or indirectly by external and independent cause as other products malfunctions, shocks, and so on
- Abnormal service or repairing by not authorized technicians.
- In no event shall AUDEIA be liable for any incidental damages (if not specifically prescribed by the states laws).

OVERVIEW

The 501 / x system was designed having in mind the needs of closed rooms where music must coexist with the use of a microphone for the voice, as in the case of entertainment at party. The system provides an innovative management of music and voice programs and has an output section designed for the use of satellite systems + subwoofer. We recommend using the system in combination with the AR series loudspeakers and SB301 subwoofers, compact systems that integrate easily in all architectural conditions

The system provides separate line inputs for music and voice, amplified outputs for a stereo speaker system plus subwoofer line. The front panel allows

direct and separate adjustment of the audio levels of speakers and subwoofers. Through dedicated software it is possible to configure the system parameters, the sub cut, enable the microphone feedback suppressor and other adjustments such as equalizers and dynamics.

FRONT PANEL

In the front panel is located:

- (1) VU METER, this METER indicates the input sound level, regulate the gain in the source to have a level that use all the dynamic but in the red limit of the METER.
- (2) Red LED that indicates an overload on the amplifier modules, restart the device if this is on and reduce the sound level.

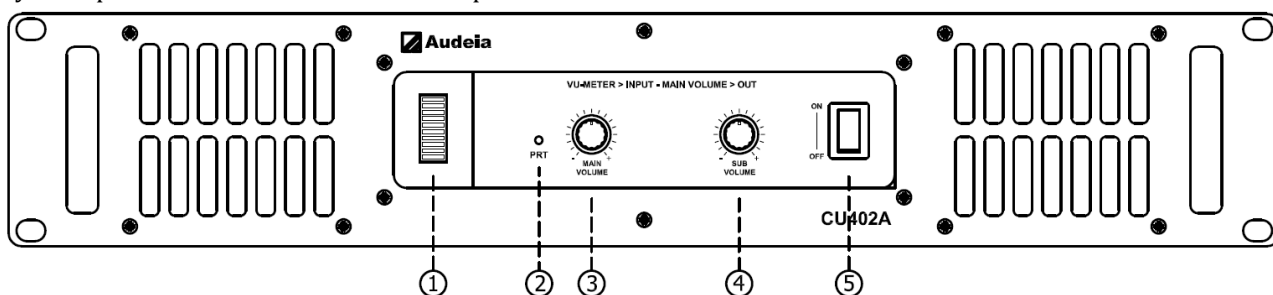

- (3) Main volume regulation, this KNOB regulates the output level of the amplifier section
- (4) Subwoofer volume regulation, this KNOB regulates the output level of the subwoofer amplifier section
- (5) Power on switch

- (1) The power supply inlet (speakon)
- (2) Subwoofer connection clamps
- (3) Speakers' connection clamps
- (4) USB plug for PC connection.
- (5) Line pass-through output, XLR balanced line
- (6) Music line input, XLR balanced line
- (7) Voice line input, XLR balanced line

REAR PANEL

In the rear panel there are all the connection interface. Following the details:

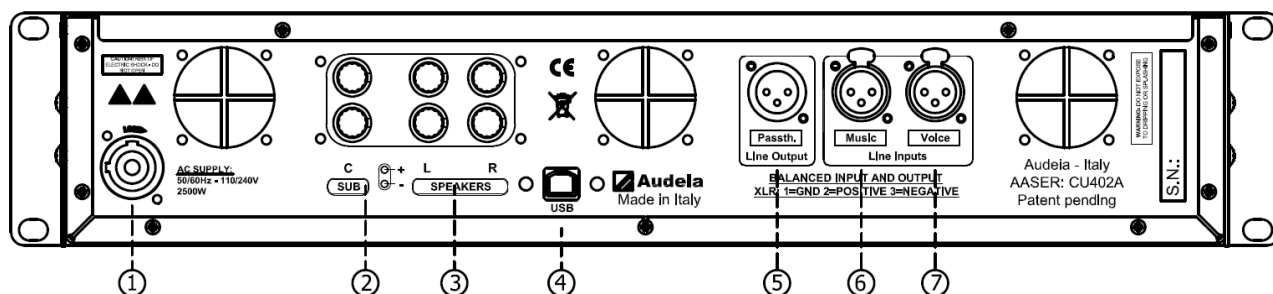

The power supply inlet and the power supply specifics change according to countries standards; until to connect the AC cord to the power source please verify that the supply voltage and frequencies printed on the rear panel are coincident with the local electrical system specifics.

CONNECTIONS

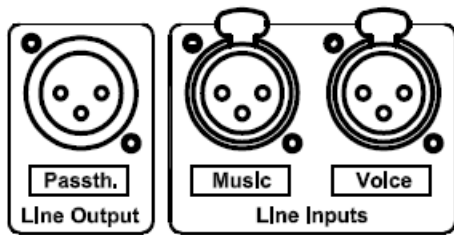

The system has two line inputs, one for the voice program and one for the music. For example, you can work using a mixer output bus to which voice channels are assigned and one to which music channels are assigned. An output is available with the sum of the two input signals. Line input and output are XLR balanced type.

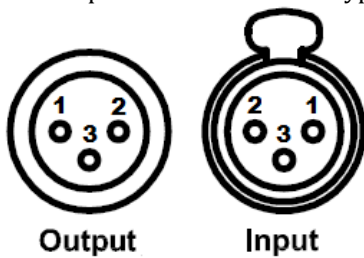

The connection are according the standards, following the details:

- 1 - GND
- 2 - Positive
- 3 - Negative

The powered output are clamp type.

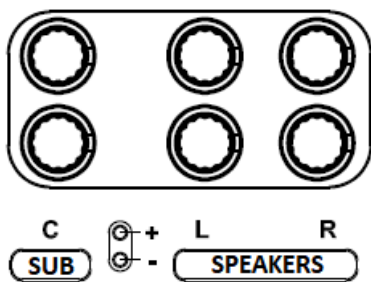

Two clamps are for subwoofer connection, four clamps are for speakers connection.

REAR HOLDER SUPPORT

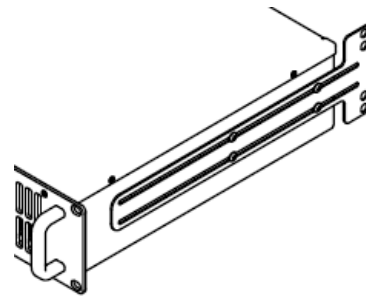

To simplify the mounting in standard rack-mount chassis the system is equipped with a adjustable flange.

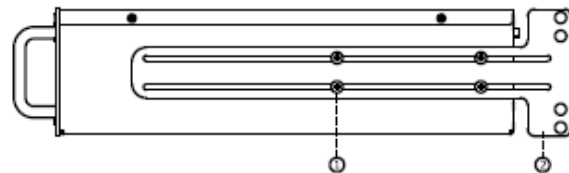

Make a measuring of the depth in the chassis, adjust the position of the flange (2) according the measure and fix the 4 screws (1).

TECHNICAL SPECIFICS***GENERAL:***

Power supply:	Universal, regulated switch mode
Nominal power requirement	AC 100V – 240V. 50/60Hz
Operating voltage	AC 90-264V
Power consumption:	
Idle	25W
1/8 of output power at 8ohm	530W

Dimensions (WxDxH):	483X320X90mm (19"x12,6"x3.5")
Weight:	8.2 kg (18lb)
Operating temperature range:	5-35°C/41-95°F

ANALOGICAL LINE INPUTS:

Number of channels:	2 balanced
Connector:	3 poles XLR

ANALOGICAL LINE OUTPUTS:

Number of channels:	1 balanced
Connector:	3 poles XLR

USB INTERFACE:

Connector type:	B type USB
-----------------	------------

AUDIO PERFORMANCES:

Subwoofer power 8ohm loaded	800W
Subwoofer power 4ohm loaded	1200W
Speaker power 8ohm loaded	2x400W
Speaker power 4ohm loaded	2x600W

Frequency response:	20Hz – 33kHz (+0/-1 dB) @ 1W 80hm
S/N Ratio input (Analog.):	min. 115dB
Crosstalk separation:	85 dB @ 1 kHz
Input sensitivity @ 8Ω	3 Vrms / 11.7 dBu
THD+N / DIM100	< 0.08% from 0.1 W to full power (typically <0.05%)
Slew rate	50 V/μs @ 8 ohm, input filter bypassed
Damping factor @ 8Ω	> 10000 @ 100 Hz

